

# FX-40 Series



## **"Reliability" - The Keyword in PIR Detection** **OPTEX reliability will surpass all your expectations.**

**The combination of the stable, secure performance of OPTEX optical technology and simplified installation creates a new standard in sensor reliability.**

When thinking about sensors, think OPTEX. Our Multi-Focus Optics, Spherical Lens Design and superior optical technology provide precise detection capability and durability for unbeatable performance. OPTEX's unique sensors satisfy your everyday needs - simplified installation combined with small innovations like easy wire knockouts and invaluable wiring guide convenience.

# Only OPTEX Fulfills All Your PIR Sensor Needs - Reliable Performance and Easy Installation

## Standard Version FX-40/40L (Alarm Memory)

RELIABILITY 1 "PERFORMANCE"

### Patented Multi-Focus Optics

The highly accurate and reliable detection pattern will maintain its sensitivity throughout the entire detection area even in high temperature or low contrast environments. Multi-Focus Optics create an extremely high vertical zone density, two or three times the size of conventional PIRs. These taller zones capture the entire body mass and enable detection of even the smallest temperature contrast against the temperature of the background. In addition, the vertical detection density has been improved to take into account dead zones created by furniture or partitions.

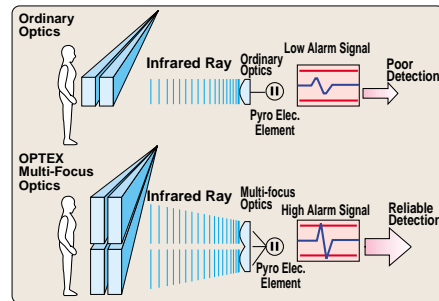

This infrared photo illustrates the difficulty that warmer summer temperatures present to PIR detectors.

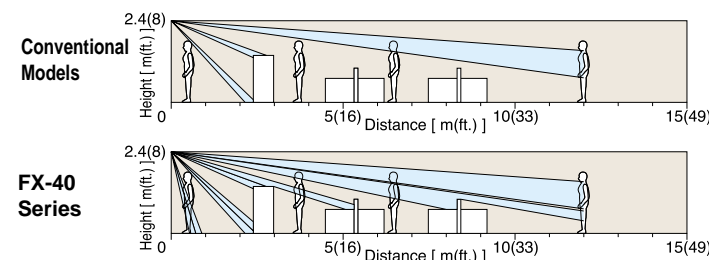

### Look Down Zone

The Look Down Zone creates greatly improved vertical sensitivity.

### Sealed Optics

Prevents drafts and small insects from getting on to the pyroelectric element. This practically eliminates the chance of false alarm due to these causes since the pyro is sealed with the inside molding of the housing cover.



### False Alarm Protection

- RFI Protection: No alarm at 20V/m from 100MHz to 1GHz
- Temperature Protection: No alarm during temperature changes from  $-20^{\circ}$  to  $+50^{\circ}\text{C}$  ( $-4^{\circ}$  to  $+122^{\circ}\text{F}$ )

### LED ON/OFF Switch

### Selectable Pulse Count: 2 or 4

### Tamper Switch (FX-40/40L/40D/40DL)

### Selectable Alarm Memory (Polarity) (FX-40L/40DL): Positive or Negative



Photo : FX-40D

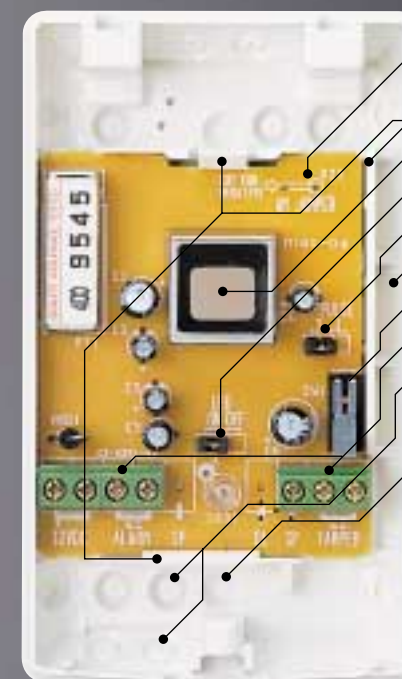

- Alarm Memory Jumper (FX-40L/40DL)
- PC Board Protection Wall
- Sensor
- LED On/Off Switch
- Pulse Count Selector (2 or 4)
- Wiring Guide
- Tamper Switch
- Terminals
- Wiring Knockout
- Mounting Knockout

### Spherical Lens Design

Conventional flat lenses inevitably create sensitivity distortion problems when they are bent to fit a curved housing. OPTEX's spherically designed lens will obtain sharp detection because no bending is required.

Designed to collect IR energy from the detection area, and focus it directly onto the pyro.

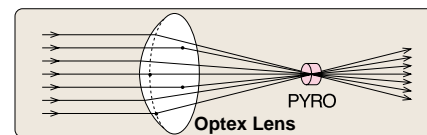

Since a flat lens is "bent," sensitivity distortion occurs at both sides of the lens (the lens surface is not directing IR energy correctly), resulting in poor sensitivity for long distance detection applications.

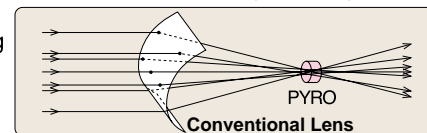

### ECO Technology (Environmental Compensation from OPTEX)

The FX-40 series features "ECO technology". This technology is designed to increase the sensor's resistance to all kinds of environmental disturbances. Logic built into the chip allows the sensor to recognize, discriminate and adjust for temperature changes within the sensor's environment. This technology also makes the unit less susceptible to false alarms due to RFI disturbances.

### Special Custom-Made Pyro Electric Element

### Temperature Compensation Circuit

The Temperature Compensation Circuit will increase detection capability under high temperature conditions where the background temperature is similar to that of the human body. It maintains a high level of false alarm protection while providing accurate detection by automatically adjusting its sensitivity according to the environmental temperature.

## RELIABILITY 2 "EASY INSTALLATION"

### No Vertical Adjustment

Vertical area adjustment and dead zones are eliminated by high density detection zones.

### Easy Wiring Knockout

Wiring knockouts can be opened with a simple push from a screwdriver. Making and adjusting wiring holes to the right width for the cables is much easier.

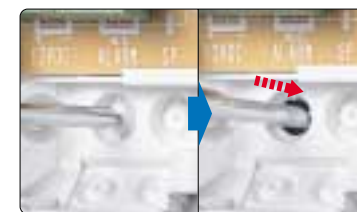

### Easy -to- View LED

### Wiring Guide & Wide Wiring Space

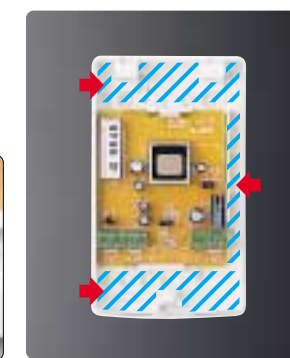

### Spare Terminal

## RELIABILITY 3 "DESIGN DURABILITY"

### Hard & Durable Spherical Lens

OPTEX's Spherical Lens provides higher durability against shocks compared to ordinary PIRs using flat fresnel lenses or mirrors.

### PC Board Protection Wall

Damage caused by the tip of the screwdriver, etc. to the PC board can be easily prevented by the PC Board Protection Wall.

### Non-Distortion Chassis

### Attractive Design

## Superior Version FX-40D/40DL (Alarm Memory)

Greater Performance Double Conductive Shielding for the Commercial Market

### Patented Double Conductive Shielding of Pyro Electric Element

The Double Conductive Shielding lets infrared energy pass through, but blocks and grounds out the RFI and light sources since it features a special conductive filter that covers the element window. A conventional metal shielded pyro electric element has an open window for infrared energy to enter. This allows RFI and light to enter and does much less to protect against many types of interference.

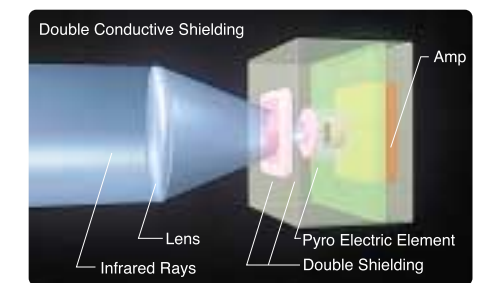

### False Alarm Protection

- RFI Protection: No alarm against 10W transmitter within 1.0m (3.3ft.), with a field strength of 30V/m within the range of 100MHz to 1GHz.
- Visible Light Protection: Provides a high protection level that exceeds H4 halogen (car headlight) within 2.4m(8ft.) or 50,000lx of morning sunlight reflection within the detection area.
- Temperature Protection: No alarm in high, low and changing temperatures from  $-20^{\circ}$  to  $+50^{\circ}\text{C}$  ( $-4^{\circ}$  to  $+122^{\circ}\text{F}$ ).

### OPTIONS

#### FA-3:

Wall & Ceiling Mount Bracket  
Horizontally  $\pm 45^{\circ}$   
Vertically  $0^{\circ}$  to  $15^{\circ}$  downwards



#### FL-60N:

Long Range (Extremely Dense Multi Layer Curtain) Lens



# DETECTION PATTERNS

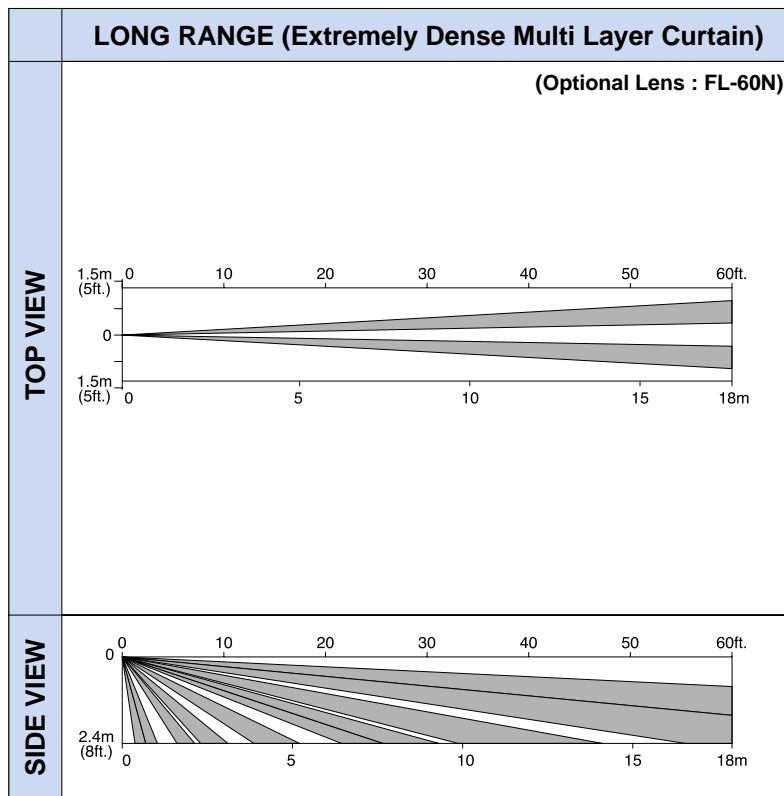
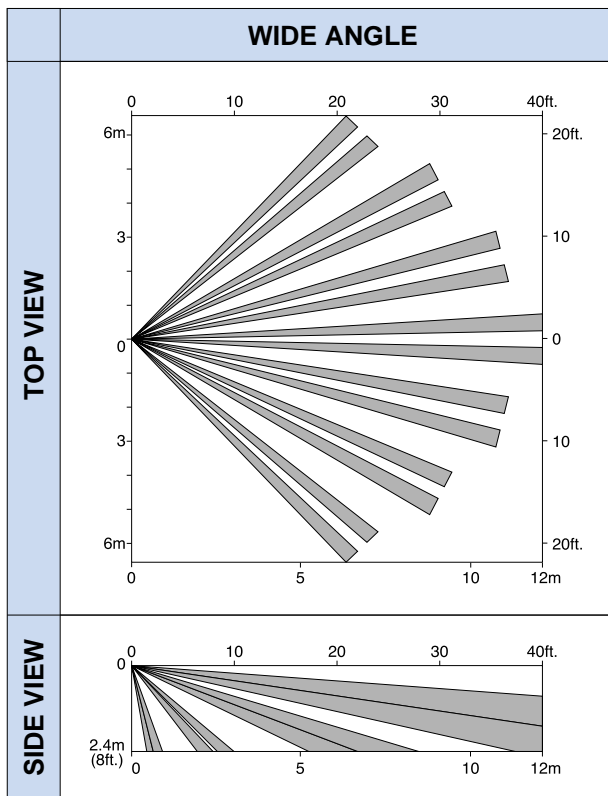

## SPECIFICATIONS

Model	FX-40, FX-40D	
Detection method	Passive infrared	
Coverage	WIDE: 12m x 12m (40ft. x 40ft.) 85βwide	
Detection zones	WIDE: 72 zones	
Mounting height	NORMAL 1.5m~2.4m (5~8ft.)	
Sensitivity	1.6°C at 0.6m/sec. (3°F at 2ft./sec.)	
Detectable speed	0.3~1.5m/sec. (1~5ft./sec.)	
LED indicator	Alarm indicator optional	
Alarm period	Approx. 2.5 sec.	
Alarm output	N.C., 28V DC 0.2A max.	
Tamper switch	N.C., Open when cover is removed	
Pulse count	Approx. 20 sec. 2 or 4	
Warm-up period	Approx. 30 sec.	
Power supply	9.5~16V DC	
Current consumption	17mA (max.)	
Weight	90g (3.2 oz.)	
Operating temperature	-20°C~+50°C (-4°F~+122°F)	
Operating humidity	95% max.	
RF interference	NO Alarm 20V/m (FX-40/40L) NO Alarm 30V/m (FX-40D/40DL)	

L Version (Alarm Memory)		
Model	FX-40L, FX-40DL	
Polarity	Positive	Negative (Cut jumper)
Alarm memory	armed: OPEN or +5~16	armed: 0~1V DC (grounded)
Current consumption	18mA (normal), 25mA (max.)	

FL-60N: Optional Lens for Long Range (Extremely Dense Multi Layer Curtain) Area Pattern	
Coverage	LONG: 18m x 1.8m (60ft. x 6ft.) Long Range
Detection zones	LONG: 20 ZONES

\*Accessories: Two Mounting Screws \*FL-60N: Pack of 5  
 LISTED: FX-40VdS • G196623, FX-45VdS • G196625 U LISTED : FX-40, FX-40D

## DIMENSIONS

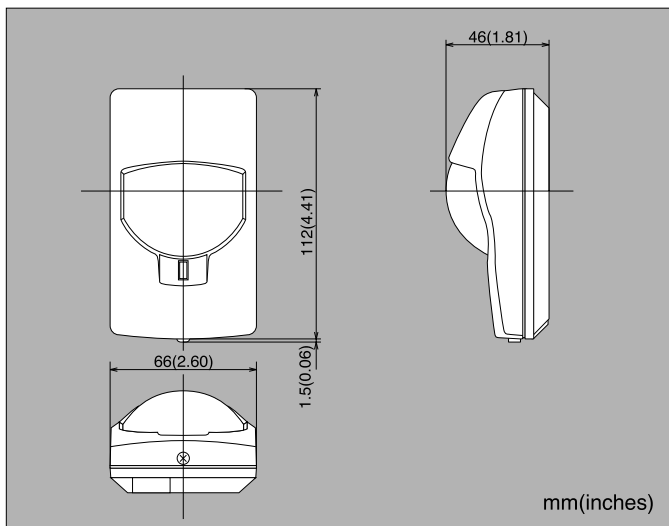

\*Specifications and design are subject to change without prior notice.

**NOTE:** This unit is designed to detect movement of an intruder and activate an alarm control panel. Being only a part of a complete system, we cannot accept responsibility for any damages or other consequences resulting from an intrusion. This product conforms to the category "Residential, Commercial and Light Industry" of EMC Directive 89/336 EEC.



### OPTEX CO., LTD.

(ISO 9001 Certified by LRQA / ISO14001 Certified by JET)  
 5-8-12 Ogoto, Otsu, Shiga, 520-0101 Japan  
 TEL +81(0)77 579 8670 FAX +81(0)77 579 8190

http://www.optex.co.jp/e  
 OPTEX INCORPORATED (USA) http://www.optexamerica.com  
 OPTEX (EUROPE) LTD. (UK) http://www.optexeurope.com  
 (ISO9001 Certified by NQA)  
 OPTEX SECURITY SAS (FRANCE) http://www.optex-security.com  
 OPTEX KOREA CO., LTD. (KOREA) http://www.optexkorea.com

"Take Care of the Environment" This catalogue uses recycled paper No. 75070-02-909-0503